

Mazzer Major V, Robur S and Kony S Electronic

QUICK START GUIDE

NOTE

This guide is a supplement to the full Major V, Robur S and Kony S instruction manual and the electronic interface guide, not a replacement. Reference the instruction manual for warnings, important safety information and more detailed instructions on using your grinder.

Grinder Overview

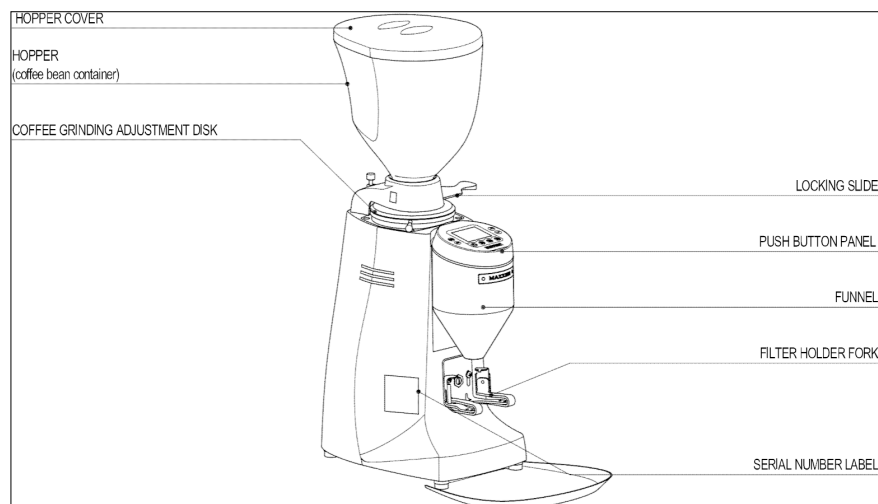

Note: hoppers designed for the Major, Robur or Kony are not compatible with the Major V, Robur S or Kony S. The tongue is not long enough to activate the hopper safety switch.

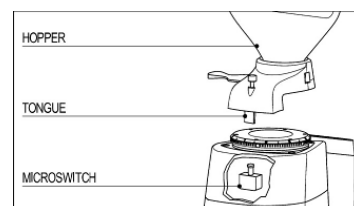
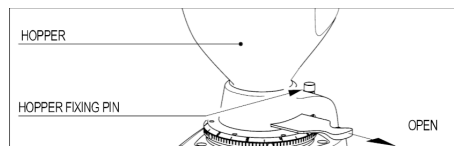

Installation

1. Remove grinder, hopper and accessories from box.
2. Ensure grinder is on a stable surface and install hopper onto grinder. Ensure the tongue of the hopper slides into the slot to activate the safety microswitch. Tighten the hopper fixing pin to the grinder body. Note: the grinder will not work without the hopper in place.

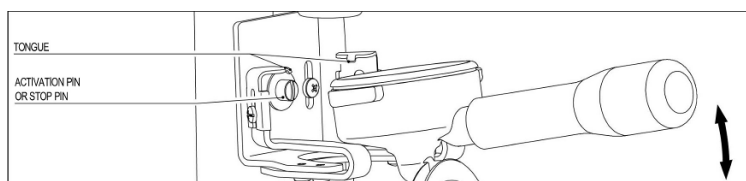

3. Screw the disk stopping pin into the disk stopping nut through a hole in the adjustment disk. Screw adjustment disk handle into adjustment disk.
4. If desired, install drip tray by sliding under front of grinder until it pops into place.
5. Adjust the fork assembly to properly fit your portafilter.
 - a. Place your portafilter into the forks by positioning the portafilter at a slight incline until the portafilter touches the stop/activation pin then straighten the portafilter out.



- b. Adjust the side tongues of the fork assembly until the portafilter is level with the ground.
6. Plug in grinder to acceptable grounded wall outlet.
7. Turn the grinder on by moving the power switch from O to I. The grinder display will light up.
8. Press the manual grind button, , and confirm the grinder motor turns on.
9. Add coffee to the hopper ensuring the hopper gate is pulled to the open position allowing coffee to flow into the grinder.
10. With the portafilter on the forks, press and hold the manual grind button, , until coffee exits the chute.
 - a. Coffee should fall into the center of the portafilter basket. If it does not, or you had other adjustment issues, reference full instructional manual for additional adjustment options.

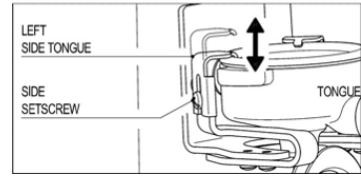

Adjusting the Grind

1. Loosen the disk stopping pin.
2. Begin grinding coffee.
 - a. When changing the grind, ensure the grinder is running while moving the adjustment disk. This prevents jamming the burrs.
3. Rotate adjustment disk either counterclockwise, to fine the grind, or clockwise, to coarsen the grind.
 - a. In some cases it may be necessary to completely remove the disk stopping pin to adjust the grind either coarser or finer. This is due to the disk stopping nut halting the travel of the adjustment disk. If this is the case, do the following:
 - i. Loosen and remove disk stopping pin.
 - ii. Adjust grind as needed.
 - iii. Realign the disk stopping nut with an adjustment disk hole for the disk stopping pin.
 - iv. Install and tighten the disk stopping pin.
4. Stop grinding.
5. Tighten the disk stopping pin.
 - a. Purge at least two doses of coffee after making an adjustment before pulling an espresso shot. This ensures the espresso being brewed is using the *new* grind setting.

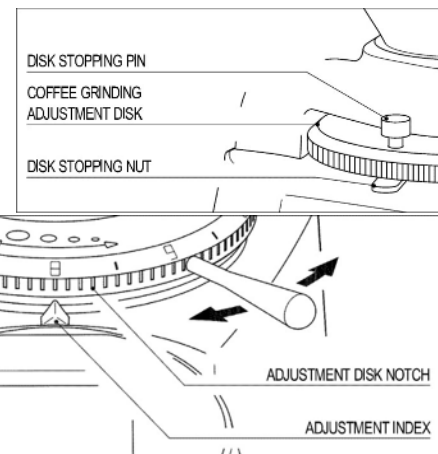

Ring Zeroing

Your Major V, Robur S, and/or Kony S comes with an adjustable numbered ring on the adjustment disk. This numbered ring may be used to indicate where the burrs touch, or for an initial grind adjustment setting. From the factory the numbered ring is set such that 0 (zero) corresponds to the burrs touching. To change the adjustment of the numbered ring, do the following:

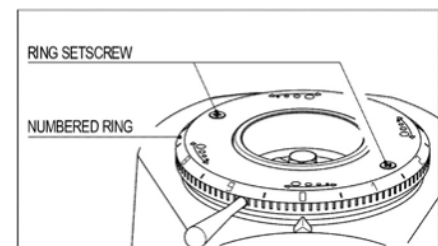

1. Turn off grinder using main power switch.
2. Close hopper gate and remove hopper.
3. Loosen and remove disk stopping pin.
4. Loosen, but do not remove, the two Phillips head ring setscrews using a Phillips screwdriver.
5. Rotate the numbered ring to the desired position and tighten ring setscrews.
6. Reassemble in reverse order.

Electronic Grinder Interface



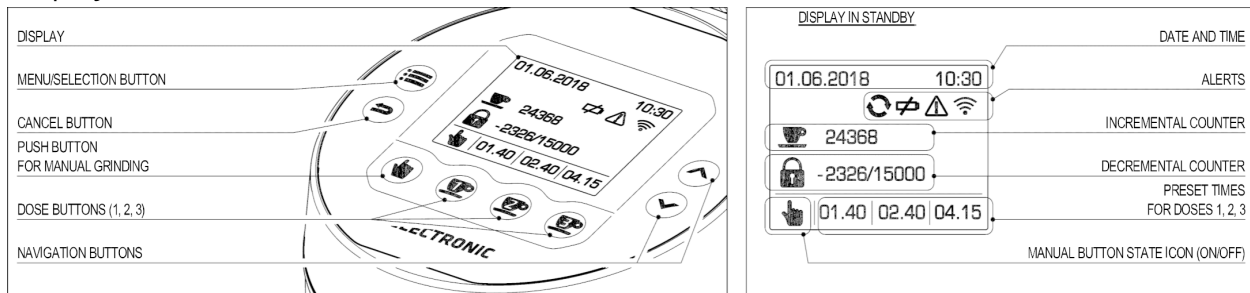



Display Overview



Changing the Operating Mode (Major V, Kony S only)

There is an activation pin switch on the body of the grinder that may be used to activate grinding. To change the operating mode from *Keyboard*, the default, to *Portafilter*, and vice versa, press the menu button, , then press the activation pin switch. The display will show the new operating mode and, after a few moments, return to the standby screen. In *Portafilter* mode the user will select the dose on the keypad first. To grind, press the portafilter into the activation pin switch. The dose does not need to be selected after each activation. The selected dose will remain until the user changes it.

Adjusting the Dose Time

1. Press and hold the menu button, .
2. Press the dose button you would like to change the time of. Either , , or . Then release both buttons. The display will change to showing the symbol of the dose you are changing and the time the dose is currently set to.
3. Adjust the dose time using the navigation buttons.  to increase the dose time and  to decrease the dose time.
4. Press and release the menu button, , to save the dose time and exit the menu.



Grind Flow Control Wires

Your Major V, Robur S, and/or Kony S allows different wire inserts to be used in the outlet insert to control the flow of grounds out of the grinder. The *Hybrid* grind flow control (GFC) wire, installed by default, is the best choice in almost all cases. If excessive clumping is occurring, you may want to try the *Anti-Clumping* GFC wire. If there is a high amount of static, you may want to try the *Anti-Dust* GFC wire. The *Anti-Clumping* GFC wire, *Anti-Dust* GFC wire and instructions on how to install them are found in a small plastic box that came with your grinder. The Kony S and Robur S use the same GFC wires. The Major V uses different GFC wires.

Cleaning the Grind Chamber

Note: you are able to clean the inside of your Major V, Robur S, and/or Kony S grind chamber without disrupting your grind adjustment setting.

Tools Needed

- 5 mm Allen key, to remove ring support screws
- Dry nylon bristled brush, to clean burrs
- Clean, dry, lint-free soft cloth, to wipe surfaces clean on ring support and grinder body
- Shop vacuum, to remove coffee from grind chamber
- Plastic spudger (optional), to remove screw caps

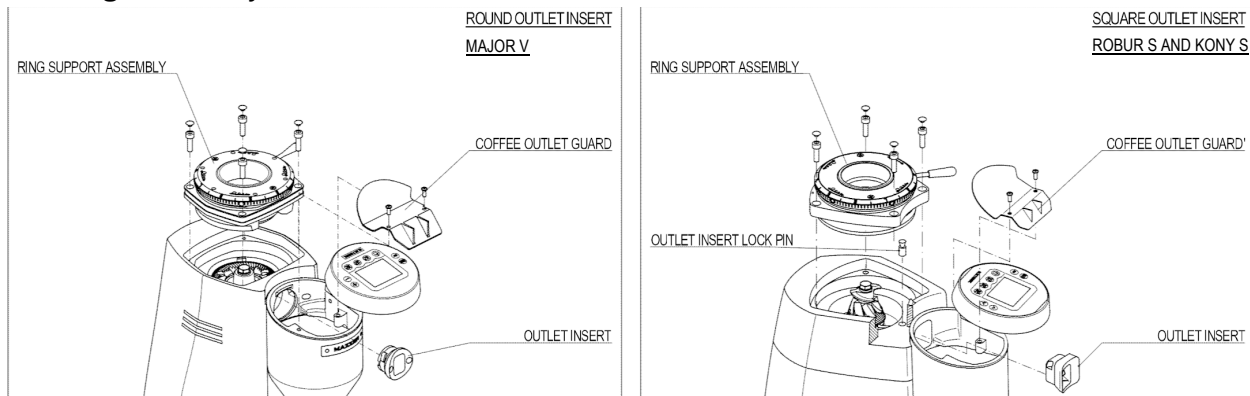

1. Turn off and unplug the grinder.
2. Close hopper gate and remove hopper. Scoop as many whole beans out of the grinder inlet and place them in hopper.
3. Remove the four screw caps using your fingernail or a spudger.
4. Remove the four screws using a 5 mm Allen key.
5. Lift up on the ring support assembly and remove it from the grinder.
6. Rotate push button display outward so you can view the inside of the funnel.
7. Remove the coffee outlet guard by removing the two Phillips screws using a Phillips screwdriver. Then lift the coffee outlet guard out of the funnel.
8. Remove outlet insert. Note: when completing this step, be careful not to damage the grind control wire inside the outlet insert.
 - a. Square Outlet Insert (Robur S and Kony S): push outlet insert toward burrs and pull up on outlet insert lock pin. Remove outlet insert by pulling it into the funnel and removing it from the grinder.
 - b. Round Outlet Insert (Major V): push outlet insert toward burrs and rotate counterclockwise a few degrees. Pull outlet insert into funnel and remove from grinder.
9. Vacuum out grind chamber, funnel and chute.
10. Using the brush, brush off the burrs to remove any built-up coffee grounds.
11. If needed, use vacuum to remove any coffee grounds that have been knocked loose.
12. Wipe all mating surfaces clean using a soft cloth. If the mating surfaces are not free of coffee grinds and/or other debris, you will have difficulty reassembling your grinder and may possibly damage components.
13. Reassemble in reverse order.