

Instruction manual

SUPER JOLLY V up

Contents

1. GENERAL DESCRIPTION.....	2
2. FOREWORD.....	2
3. WARNINGS REGARDING SAFETY.....	3
4. DIMENSIONS.....	4
5. INSTALLATION AND WIRING.....	4
6. WARNING REGARDING OPERATION.....	6
7. OPERATION OF THE APPLIANCE.....	7
7.1. Preliminaries	7
7.2. Switching the appliance on and off	7
7.3. Adjusting grinding	8
7.4. Coffee dose adjustment	8
7.5. Pressing (Grinder-Dosers)	9
8. APPLIANCE MAINTENANCE	9
8.1. Filter holder fork setting	9
8.2. Noise level	10
8.3. Safety devices	10
8.4. Cleaning the appliance	10
8.5. Administrator menu	12
9. DISPOSAL.....	13

1. GENERAL DESCRIPTION

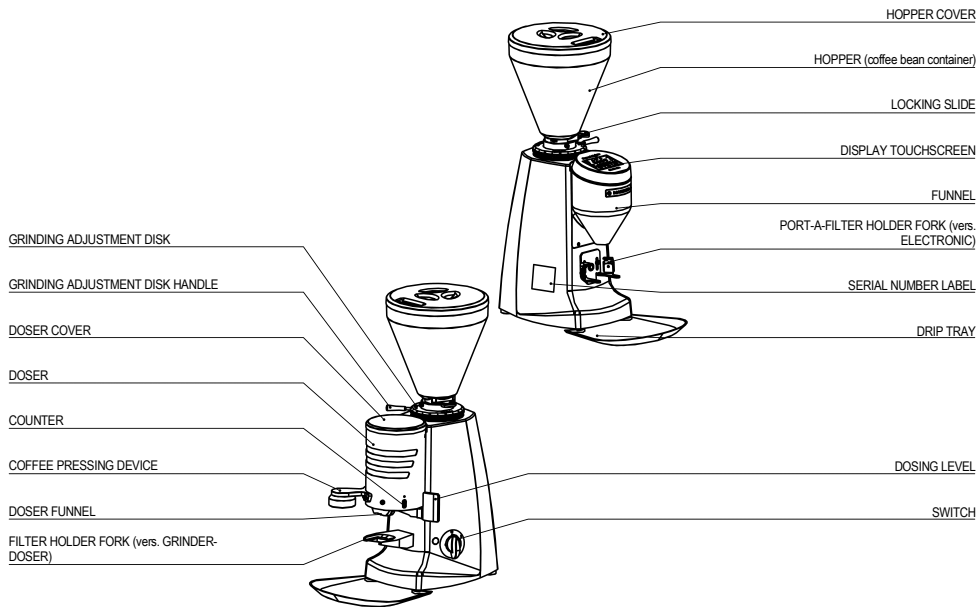

Electronic version user interface

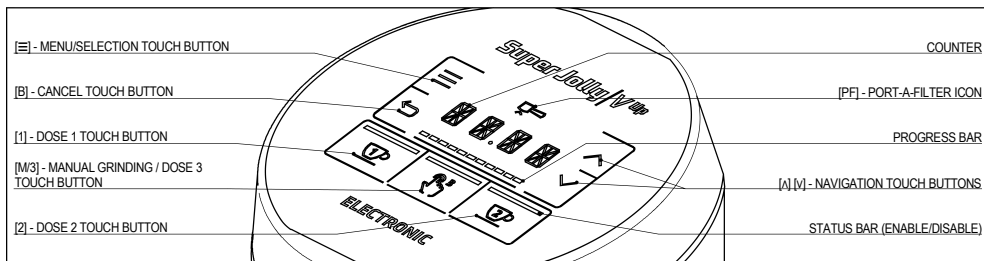

2. FOREWORD

Read this manual from cover to cover before using the appliance as it contains important instructions for the safety, operation and maintenance of the appliance.

Look after this manual and keep it in a safe place. The manufacturer reserves the right to make changes to the product and to the manual.

3. WARNINGS REGARDING SAFETY

The coffee grinders, grinder-dosers and electronic grinder-dosers are intended for skilled personnel only for professional use and not for household use. The user must be an adult.

This electrical appliance must be used in conformity with the rules in force governing safe operation:

- Do not allow children or incapable persons to use the appliance and/or play with the appliance.
- Grind solely coffee beans. Any other use is understood to be improper, and consequently hazardous. Do not use the appliance for grinding other types of food, or anything else.
- Do not use the doser (Grinder-Doser version) to store foods or measure them.
- When operating the appliance, beware of the moving mechanical parts' in the area of the grinding blades and of the ground coffee outlet. Before removing the hopper from the grinding system, disconnect the power supply. Avoid removing foreign bodies from the grinding system or hopper without first unplugging the appliance from the mains.
- Take care, as the grinding blades may continue rotating for a short while even after the appliance is switched off.
- The user is not authorized to re-

move screws or any parts screwed onto the appliance.

- In the event the appliance is not working properly or is faulty, contact skilled technical personnel, and do not attempt to make repairs yourself.
- In the event of damage of the power cord or plug, contact skilled technical personnel in order to avoid any hazard.
- Before performing any work on the appliance, including cleaning and/or maintenance, disconnect it from the power supply by unplugging. The removal of the plug has to be such that an operator can check from any of the points to which he has access that the plug remains removed. Turning off the appliance using its master switch does not assure the same conditions of safety.
- Do not tamper with the appliance.
- When the appliance is left unattended, the appliance's power supply must be disconnected using its master switch (for example, at night, during work breaks, midweek closing or holidays).
- The hopper must be fastened to the appliance by means of the relevant screw.

- Do not let liquids of any kind come into contact with the internal or external parts of the appliance.
 - Never put ground coffee in the hopper intended only for coffee beans.
 - Do not tug on the supply cable to unplug the appliance from the mains.
 - Do not touch the appliance with damp or wet hands or feet.
 - Do not use the appliance barefoot.
 - Due to the weight of the grinder, use appropriate precautions for handling it. Maximum weight: 15kg.
 - The packaging materials must be kept out of the reach of children as they represent a potential source of danger. Keep the packaging until the warranty has expired.
 - This appliance is intended for use at maximum altitudes of 2000 meters.
 - In event of disposal of this appliance, follow the instructions in chapter 9.
- The manufacturer cannot be held responsible for bodily injury or damage to property if these regulations are not complied with.**

4. DIMENSIONS

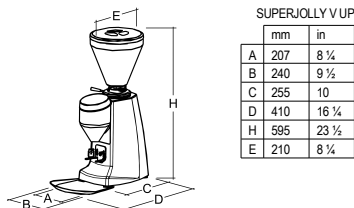

5. INSTALLATION AND WIRING

Installation and maintenance (as stated in section 8, of this booklet), shall be solely carried out by person having knowledge and practical experience of the appliance, in particular for what is concerning safety and hygiene, in conformity with the safety rules in force.

Incorrect installation may result in injury of persons or animals, or damage to property, for which the manufacturer cannot be

held responsible.

- On opening the packaging, check carefully to make sure the appliance is intact and that there are no signs of damage. If in any doubt, do not use the unit and contact your service reference.

- The appliance must be placed on a stable, flat surface (we recommend to install the appliance at an height between 80 and 100 cm from the floor).

- Before plugging in the appliance, make sure the voltage and frequency values of the supply mains correspond to the ratings indicated on the label featuring the appliance's technical data.
 - The wall socket must be fitted with an efficient earth contact. Consequently, it is essential to make sure the earth system is efficient and in conformity with current safety rules. If in any doubt, have the system thoroughly checked by personnel with the appropriate professional skills.
- It is compulsory to earth the appliance. The manufacturer cannot be held responsible in the event this regulation is not complied with.**
- It is essential to make sure the ratings of the system are suitable for the power absorbed by the appliance - as indicated on the label featuring the technical data - and that the wall socket is protected against overcurrents.
 - Do not use extension cables, plug adapters for multiple sockets or makeshift connections.
 - The motor must rotate clockwise. If the rotation of three-phase motors is to be inverted, by inverting the two power supply wires inside the plug, this must be carried out by skilled personnel.
 - The appliance is suitable for indoor use only. Do not install the appliance outdoors.
 - For an optimal functioning of the appliance a room temperature range from 15°C to 35°C is suggested.
 - Thoroughly clean the appliance at the first installation; follow the instructions in chapter 8.
 - The appliance is not suitable for installation in an area where a water jet could be used.
 - For the correct use of the grinding blades, at the first installation or whenever the grinding blades have been replaced, grind some doses of coffee. Do not use those first doses.
 - The appliance is only to be installed in locations where its use and maintenance is restricted to trained personnel.
 - A minimum clearance of 15 cm (6.0 inches) is required between the grinder and any adjacent walls (or other adjacent appliances). Frontal side must be open.
 - Do not install the appliance near to water dispenser or similar product that could throw water jet on the appliance.
 - The filter holder fork must be suitably set according to the instructions in chapter 8.

6. WARNING REGARDING OPERATION

- Do not leave the appliances turned ON without coffee in the hopper.
 - In the Grinder-Doser version, avoid pulling the dosing lever partially, always pull it all the way.
 - When adjusting the grind (grind setting point), do not put the grinding blades (burrs) in touch when motor is turning. This will damage the grinding blades (burrs) and affect the grind quality.
 - Do not insert, when filling the hopper with coffee beans, foreign objects. Handle with clean hands.
 - After any hopper filling and in normal use of the appliance, the hopper lid must be positioned correctly.
 - Do not beat the screen with your fingers or other objects that could damage it.
 - In the Electronic Grinder-Doser version, for the appliance to function at its best, on its first installation and every time the hopper is cleaned, after having ground a few coffee doses, clean the inner surface of the funnel with a dry brush.
- OPERATING RANGE OF THE MOTOR
- In the versions with single-phase motors, observe the duty cycle stated in the label located on the side of the appliance.
- E. g. : a data on the label 35s ON / 45s OFF points out an allowed duty cycle of 35 seconds switched on and 45 seconds switched off.
- Appliances with three-phase motors are allowed for continuous working.
- In order to achieve good grinding, it is nonetheless recommended to operate the appliance at intervals, allowing it to operate for no more than 10-15 minutes at a time.

7. OPERATION OF THE APPLIANCE

7.1. Preliminaries

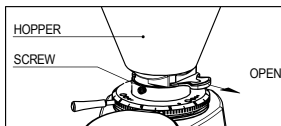

Make sure the hopper is positioned correctly on the appliance and fixed to the casing with

the relevant screw.

Close the locking slide and fill the hopper with coffee beans. Open the locking slide so that the beans are allowed to drop into the grinding system.

7.2. Switching the appliance on and off

Grinder-dosers

- *Manual version*

Operate the switch for start/stop
Start: switch in position I.
Stop: switch in position O.

- *Version with time switch (timer)*

In order to switch on the appliance, turn the timer knob clockwise.

The appliance switches off automatically. In order to switch it off manually, turn the knob anti-clockwise all the way.

- *Automatic version*

In order to power up the appliance, turn the on-off switch knob to I.

The appliance starts automatically every 12 portions of coffee. It switches off automatically when the doser is filled with ground coffee. In order to switch the appliance on manually, the switch knob must be turned all the way (to position ▶).

In order to switch off the appliance manually, set the on-off switch knob to O.

In order to collect the portions of ground coffee dispensed, insert the coffee machine's filter holder all the way onto the fork-shaped support under the ground coffee outlet.

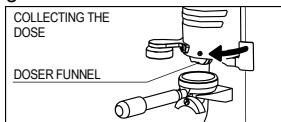

In order to release a portion of ground coffee, the doser lever must be pulled all the way and allowed

to return on its own. Pull twice in a row for a double portion.

The appliance is equipped with a funnel system to optimize the centering of the coffee falling from the doser into the portafilter. It is possible to adjust

the position of the fork according to the instructions in chapter 8.

Electronic Grinder-Dosers

In order to power up the appliance, set the on-off knob to I.

The electronic grinder-dosers are equipped with a fork which allows the coupling of the filter holder. This fork, which is suitable for most filter holder shapes and diameters, must be suitably set according to the instructions in chapter 8.

The electronic grinder-dosers can operate with two different operating modes. In **KEYBOARD** mode, grinding start is managed by pressing a key on the keypad cover. In **PORT-A-FILTER** mode, grinding start is managed by the activation pin on the fork, and the icon [PF] will appear. To toggle the operating mode, press the menu [≡] button then press the activation pin. The display will show the new operating mode set, and after a few moments will return to the stand-by screen.

The [M/3] button can be set as manual dose or as dose 3. For this setting and for all the function of the administrator menu, see chapter 8.

- *KEYBOARD operating mode*

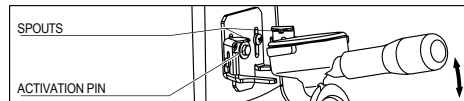

Position the filter holder, pushing it until it touches the activation pin and secure it using the appropriate spouts. It is recommended that you keep the filter holder slightly inclined, and straighten it once it has reached the activation pin. Coffee grinding and dosing takes place by pressing one of the dose buttons [1], [2] or [M/3]; grinding continues for the time set for the selected dose button. One can manually activate the appliance keeping pushed the push button for manual grinding. Hold down the push button [M/3] for manual grinding and the grinder will grind until you lift the finger. We suggest to use the push button for manual grinding to adjust the grinding of the appliance.

- *PORT-A-FILTER operating mode*

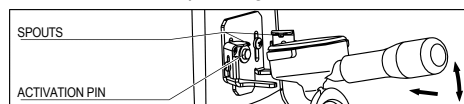

Select from the keyboard the dose to be dispensed by pressing the desired key [1], [2] or [M/3], the selected icon will be over-marked in orange. Position the filter holder, pushing it until it presses the activation pin. It is recommended that you keep the filter holder slightly inclined, and straighten it once it has reached the activation pin. The pressure of the pin will activate grinding. Now it is possible to leave the cup, that will remain in position anchored to the two spouts. Grinding continues for the time set for the selected dose button.

One can manually activate the appliance keeping pushed the push button for manual grinding [M/3]. Hold down the push button for manual grinding and the grinder will grind until you lift the finger. We suggest to use the push button for manual grinding to adjust the grinding of the appliance.

• **Grinding interruption**

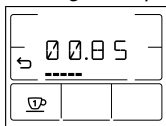

During grinding, the display shows the symbol of the selected dose, grinding progress (by means of a visual representation), and grinding time. To cancel the grinding in progress, press the cancel button [B].

During grinding, if necessary, press the button of the selected dose to pause grinding for 30 seconds. To resume grinding, press again the button of the selected dose or the activation pin, depending on the operating mode. If grinding is not restarted within 30 seconds, the dose will be cancelled.

The counter on the display increment by one unit for each dose 1 completed and by two units for each dose 2 completed. For each dose 3, for each dose cancelled and for each manual dose the counter increment according to the ratio between the actual time of grinding and the time set for dose 1.

In order to switch off the appliance manually, set the on-off switch knob to O.

7.3. Adjusting grinding

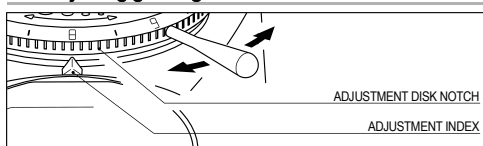

In order to achieve finer or coarser grinding, the adjustment disk located under the hopper must be adjusted using the relevant handle. In order to increase the coarseness of the ground coffee, the disk must be rotated clockwise; to decrease, turn the disk anticlockwise. Indicatively, a 1 notch rotation of the disk corresponds

to a variation in the brewing time of the espresso machine of 3 seconds.

The disk remains in the chosen position without having to be locked in place. The adjustment must be performed with the motor on, and preferably without any coffee between the grinding blades. Grind small amounts of coffee in order to determine the optimal degree of fineness.

In the Electronic Grinder-Doser version, before checking the fineness of the ground coffee, grind some doses of coffee to fill the duct between the grinding area and the outlet. This operation must be done whenever the grinding setting has been changed in order to empty the duct of the previous ground coffee. The change of the grinding setting might vary the weight of the doses. Therefore adjust the doses only after the grinding setting.

In the Grinder-Doser and Electronic Grinder-Doser versions, if the coffee comes out of the espresso coffee machine very quickly, it means the coffee is ground too coarse. Vice versa, if it comes out too slowly, it means the coffee is ground too fine. Nonetheless, bear in mind that there are many conditions liable to influence the correct supply, such as the weight of the portions, the compacting, the espresso machine settings, and the cleaning of the filters.

7.4. Coffee dose adjustment

Grinder-Dosers

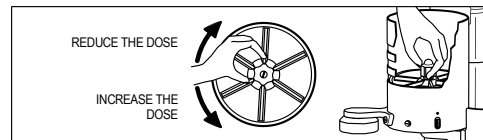

In order to adjust the size of the portion dispensed, the small knob located in the centre of the ground coffee storage container must be turned while holding still the star shaped dosing unit.

By turning the small knob clockwise, the portion is reduced. Turning it anticlockwise results in an increase. One turn of the knob correspond to about 0.5 gr of dose variation.

Electronic Grinder-Dosers

Coffee dosing in electronic appliances is time-managed, the higher the time set, the greater the weight of the dose. It is possible to set up to three different grinding times,

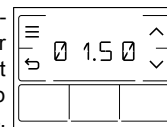

associated to the buttons [1], [2] and [M/3]. Before setting the dose, you should adjust correctly the grain size of the ground coffee.

To adjust dosing, proceed in the following manner:

- Press in sequence the menu button [≡] and the button of the dose you want to adjust ([1], [2] or [M/3]). The display shows the screen to change the time for the selected dose.
- Use the navigation buttons [▲] or [▼] to increase or decrease the dose time. Approximately, a change of 0.1 seconds is equivalent to a change of dose of 0.2 grams (0.07 ounces).
- Press menu button [≡] to confirm the new time. Instead, press the cancel button [B] to exit the procedure without saving the changes.
- Use a digital precision scale to check the weight of the dose and, if necessary, repeat above mentioned operation.

When you are inside the adjusting program it is not possible to operate the appliance.

7.5. Pressing (Grinder-Dosers)

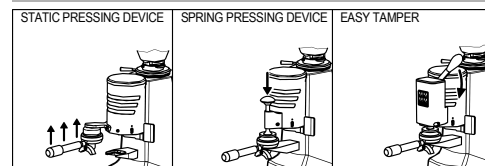

STATIC PRESSING DEVICE: place the filter holder against the underside of the pressing device and push upwards.

SPRING PRESSING DEVICE: place the compacting disk against the upper face of the filter holder inserted in the fork-shaped support and press down on the spring pressing device knob.

EASY TAMPER: place the filter holder on the fork aligned with the pressing disc and pull down the lever up to the support of the pressing disc on the edge of the filter holder.

8. APPLIANCE MAINTENANCE

Instructions stated in this section shall be solely carried by persons having knowledge and practical experience of the appliance, in particular for what is concerning safety and hygiene, after disconnecting the appliance from the mains supply by removing the plug from the power outlet.

In order to assure the lasting efficiency of the appliance, skilled technical personnel must be called in to perform periodical maintenance, including detailed checks of the state of those components subject to wear.

- It is recommended to use original spare parts only.
- It is essential to check monthly the state of the supply cable and plug.

In the event the supply cable or plug are damaged, call in skilled technical personnel to replace them, this to prevent any risk.

In CE-certified appliances, a special tool is required to open the base plate to get at the cable.

- For an optimal functioning of the appliance a room temperature range from 15°C to 35°C is suggested.
- Grind solely coffee beans. Any other use is understood to be improper, and consequently hazardous. The manufacturer cannot be held responsible for any damage as a result of improper or incorrect use. Do not use the appliance for grinding other types of food, or anything else.
- We recommend to check periodically the state of the grinding blades. Keeping the grinding blades in an excellent state assures high-quality grinding, resulting in greater productivity and limited over-

rheating.

For the correct use, whenever the grinding blades have been replaced, grind some doses of coffee. Do not use those first doses.

8.1. Filter holder fork setting

Grinder-Dosers

It is possible to adjust in horizontal, vertical and depth directions the portafilter support position.

- For the depth adjustment loosen the bottom screws, move the stop plate to desired position and fix the bottom screws again.

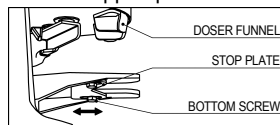

- For the horizontal/vertical adjustment loosen the front screws, move the filter holder fork to desired position and fix the front screws again.

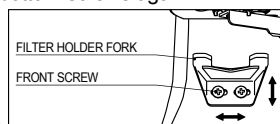

Electronic Grinder-Dosers

To allow the correct engagement of the filter holder, the fork must be set using the side tongues.

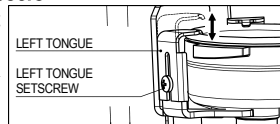

Loosen the setscrews of the side tongues and place the filter holder on the fork. Rest the side tongues on the top surface of the filter holder and secure them again.

If, even by placing the tongues at the maximum height allowed, spouts are too low in relation to the top surface of the filter holder; replace the tongues and use the longer ones available within the packaging.

It is also possible, in order to centre the fall of coffee inside the filter, to adjust the position of the filter holder height.

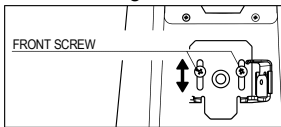

To change the height of the fork, loosen the front setscrews of the base. Place the

whole fork at the desired height and secure again the front screws.

8.2. Noise level

European Union

The daily personal noise exposure of a worker, due ONLY to an appliance's limit operation of 240 minutes per eight hours, is 74dB(A) ± 2.2dB(A) (valued as acoustic pressure).

According to European Directive 2003/10/EC, during the appliance's normal operation, no provisions are to be taken in order to prevent such risks arising or likely to arise from noise exposure at work.

USA & Canada

The noise level of our appliances is included within the limits stated in U. S. regulation 29 CFR 1910.95 ('Occupational Health and Environment Control - Occupational noise exposure') for eight hours continuously in a day (in reference to a noise exposure due solely to appliance operation).

Said noise level has been determined on identical news appliances.

8.3. Safety devices

Thermal overload protection

The appliance's motor is protected against overheating resulting from overcurrents by a thermal overload protection which, when tripped, cuts off the power supply to the motor. Should the protection trip as a result of anomalous operation, such as the grinding blades jamming, the appliance must be turned off using the on-off switch, unplugged from the mains, and skilled technical personnel contacted. Never perform any work on the appliance while it is attached to the mains, to avoid the risk that motor turns on suddenly. If the appliance overheats as a result of the motor stopping, allow the appliance to cool down before per-

forming any repair work.

Hopper safety screw

The hopper must always be attached to the upper grinding blade holder using the relevant captive screw, which must not be removed by the user under any circumstances.

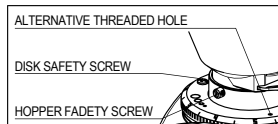

Disk safety screw

In order to prevent the adjustment disk from being removed - which would make the rotating parts accessible - there is a safety screw on the actual disk: fasten the screw in whichever of the two holes on the disk enables the wider and most suitable range of grinding adjustment, and must not be removed by the user any circumstances.

Coffee outlet guard

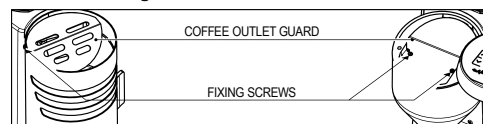

The coffee outlet guard must always be fixed to the doser (Grinder-Dosers), or to the funnel (Electronic Grinder-Dosers), using the relevant screws, which must never be removed by the user. The removal of the coffee outlet guard can be done by skilled technical personnel only after disconnecting the appliance from the power supply by unplugging. Before reconnecting the appliance to the power supply, fix the coffee outlet guard.

8.4. Cleaning the appliance

The appliance must not be cleaned using water jets. Do not install the appliance in rooms where water jets are used for cleaning.

The appliance must be cleaned weekly by skilled technical personnel only.

Use perfectly clean, disinfected cloths or brushes for cleaning.

Do not use abrasive products as these are liable to take the sheen off shiny parts.

Hopper cleaning

Wash the hopper once it has been removed from the appliance, using neutral soap and water, rinse abundantly with lukewarm water and dry thoroughly. It is advisable to clean the hopper periodically. Once the hopper has been cleaned it must be put back on the appliance properly, fixing it with the relevant screw.

Grinder-Dosers cleaning

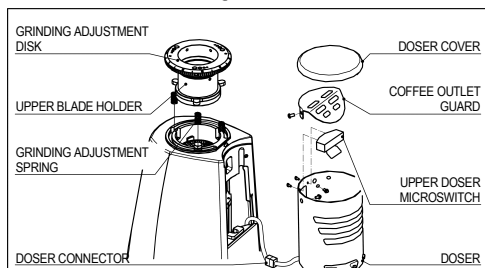

Remove the safety screw which prevents the adjustment disk from being removed. Unscrew the adjustment disk by turning it clockwise. Having removed the upper grinding blade holder, clean the grinding blades, threads and the entire grinding system thoroughly using a clean brush and cloth. To clean the threads of the grinder please use a small wire brush. We recommend to check that the threads of the grinder and of the grinding adjustment disk are clean: to do so screw the adjustment disk anti-clockwise without the upper blade holder until the end. If the grinding adjustment disk can not turn easily, than it is necessary to clean again. If the cleaning operations are not done as above the risk is to damage the threads.

Remove from the doser the ground coffee by pulling repeatedly the doser lever.

After removing the doser cover, clean the internal surfaces of the doser using a dry brush and cloth; remove the material removed by pulling the doser lever. Thoroughly clean on the bottom of the doser the exit hole of the ground coffee with a dry cloth.

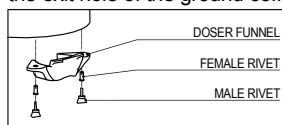

Remove the male rivets, pull out the doser funnel and remove the female rivets. Clean the

doser funnel using neutral soap and water, rinse abundantly with lukewarm water and dry thoroughly.

Remove the coffee outlet guard after having unscrewed the relevant setscrews on the sides of the dosing assembly.

For automatic version only: after unscrewing the dosing device unit's fixing screws, remove the unit whilst making sure to disconnect the connector. Remove the dosing device's upper microswitch once the fixing screws have been unscrewed. Thoroughly clean the upper microswitch, inside of the dosing device unit (as specified below) with a dry brush and cloth.

For a thorough cleaning of the dosing assembly, fol-

low the instructions below:

- Remove by unscrewing the knob cap;
- Unscrew the hexagonal-head screw that fix the coffee dose adjustment knob;
- Unscrew (anticlockwise) the coffee dose adjustment knob holding the doser's stars unit pushed down;
- Remove from the central pin the dosing stars assembly;
- Remove the spring from the central pin;
- Clean thoroughly the bottom of the doser, especially the sharp edges on sight and the outlet of the ground coffee;
- In order to reassemble the doser, follow the previous instructions in inverted order; pay attention that the feather of the coffee-outlet covering section plate is correctly set in the proper slide on the side of the basin.

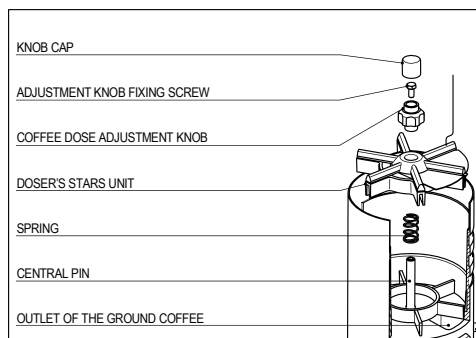

Secure the top microswitch using the relevant screws. After restoring the connector, secure the dosing assembly to the appliance using the relevant screws. Refit the coffee outlet guard, securing it appropriately with the appropriate screws.

Insert partially the female rivets in to the doser funnel holes, place the doser funnel into position under the doser then push the female rivets to complete insertion. Fix the doser funnel by using the male rivets.

Please check that the grinding adjustment springs are on their place. Having refitted the upper grinding blade holder in the relevant slot, please lubricate, with grease suitable for food contact, the threads of the grinding adjustment disk and its underneath surface which touches the upper grinding blade holder. Screw the adjustment disk by turning it anticlockwise, put the self-locking screw back in whichever of the two holes on the disk enables the best adjustment and, having refitted the hopper and secured, adjust the grinding as required.

Electronic Grinder-Dosers cleaning

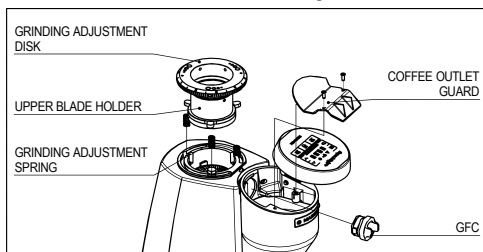

Rotate counterclockwise the display cover, and remove the coffee outlet guard.

Rotate a few degrees counterclockwise the GFC (Grind Flow Control) until it can be removed.

Remove the safety screw which prevents the adjustment disk from being removed. Unscrew the adjustment disk by turning it clockwise. Having removed the upper grinding blade holder, clean the grinding blades, threads and the entire grinding system thoroughly using a clean brush and cloth. To clean the threads of the grinder please use a small wire brush. Be very careful when cleaning the GFC not to damage or deform its internal metal wire.

We recommend to check that the threads of the grinder and of the grinding adjustment disk are clean: to do so screw the adjustment disk anti-clockwise without the upper blade holder until the end. If the grinding adjustment disk can not turn easily, than it is necessary to clean again. If the cleaning operations are not done as above the risk is to damage the threads.

Reinsert the GFC into its seat and secure it by turning clockwise; check the alignment of GFC with the first part of the chute. Refit the coffee outlet guard, securing it appropriately with the appropriate screws. Refit the cover turning it clockwise by 180°.

Please check that the grinding adjustment springs are on their place. Having refitted the upper grinding blade holder in the relevant slot, please lubricate, with grease suitable for food contact, the threads of the grinding adjustment disk and its underneath surface which touches the upper grinding blade holder. Screw the adjustment disk by turning it anticlockwise, put the self-locking screw back in whichever of the two holes on the disk enables the best adjustment and, having refitted the hopper and secured, adjust the grinding as required.

8.5. Administrator menu

Enter the user menu. Next, press the "admi" item and enter the specific password (0000 by default).

Once logged in, use the [Λ] and [V] icons to scroll through the submenus; then press [≡] to confirm the selection.

A list and description of the available options is provided below.

- **"totc"**
Displays the total counter which cannot be reset.
The number is divided into 2 screens; these can be scrolled through by means of the [Λ] and [V] icons.
- **"1max"**
Sets the maximum time that can be selected in the user menu for a single dose.
To adjust the maximum grinding time, press [≡] and then use either the [Λ] or [V] icon.
To confirm the change, press the [≡] icon.
- **"2max"**
Sets the maximum time that can be selected in the user menu for a double dose.
To adjust the maximum grinding time, press [≡] and then use either the [Λ] or [V] icon.
To confirm the change, press the [≡] icon.
- **"3max"**
Sets the maximum time that can be selected in the user menu for a third dose.
To adjust the maximum grinding time, press [≡] and then use either the [Λ] or [V] icon.
To confirm the change, press the [≡] icon.
- **"mdos/3dos"**
Enables/disables the operation of the manual grind dose icon or activates the manual grind icon as the third dose.
To do so, press [≡] and then use the [Λ] or [V] icon to enable or disable the manual grind, or enable the icon as a third dose.
To confirm the change, press the [≡] icon.
- **"lock"**
Locks/unlocks the option to modify the single or double dose times from the user manual.
To do so, press [≡] and then use the [Λ] or [V] icon to lock "enbl" or unlock "dsbl" the option to modify the dose times.
To confirm the change, press the [≡] icon.
- **"rset"**
Resets the partial counter.
To do so, press [≡] and then use the [Λ] or [V] icon to reset the partial counter "conf" or leave it as it is "esc".
To confirm the change, press the [≡] icon.

- **"hrst"**
Can be used to perform a hard board reset.

To perform a hard reset, press the [≡] icon and then press [≡] again to confirm the operation.

- **"pswd"**
Changes the administrator menu login password.

To change the password, press the [≡] icon (the last saved password will appear on the display). Use the [Λ] or [v] icons to

set the flashing digit and press to confirm; the next digit will then flash. To save the full password, press the [≡] icon.

WARNING!!!

IF THE PASSWORD IS CHANGED AND SUBSEQUENTLY LOST, ADMINISTRATOR-RESERVED CHANGES CAN NO LONGER BE MADE. SHOULD YOU ENTER THIS OPTION BY MISTAKE, SWITCH OFF THE APPLIANCE (POSITION "O"). THIS WILL PREVENT THE PASSWORD FROM BEING CHANGED.

9. DISPOSAL

Do not litter: dispose of the packaging materials according to the laws in force.

Should you decide not to use the appliance any more, remember to unplug it so that it cannot be used, and then cut the cable in the point where it comes out of the appliance.

Contact specialized firms for information on the disposal of the components of the appliance.

INFORMATION FOR USERS RESIDING IN THE EUROPEAN UNION

Pursuant to art. 26 of Legislative Decree of March 14, 2014, no. 49: "Implementation of Directive 2012/19/EU on Waste Electrical and Electronic Equipment (WEEE)".



The crossed bin symbol shown here and on the equipment or its box indicates that, at the end of its useful life, the product (EEE) must be collected separately from other waste, with prohibition of disposal with mixed waste.

For more information, visit www.mazzer.com.



For more information and suggestions visit our website



FAQ

Mazzer Luigi S.p.a.

Original instructions. All right reserved. It is prohibited to reproduce, adapt or translate this document without prior written authorization.

ISJ0L0120_EN - 11/2022

